

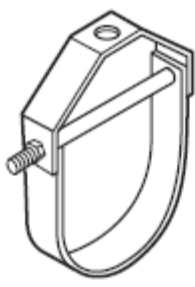

Adjustable swivel ring

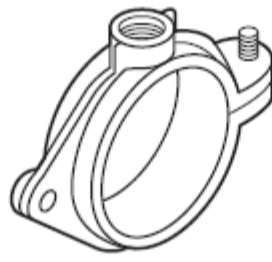

Clevis hanger



Split ring

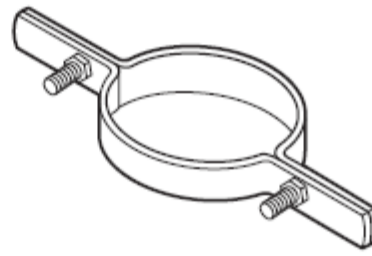

Riser clamp

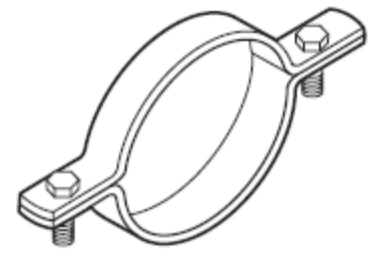

Pipe clamp

Ceiling flanges

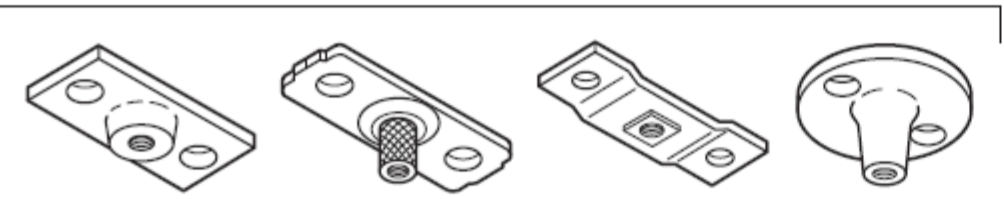

Side beam attachments



Eyelet



Offset eyelet

C-type clamps

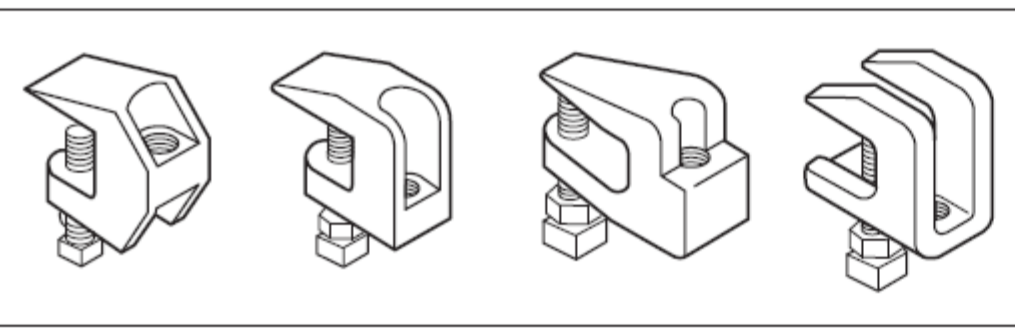

Universal beam clamps

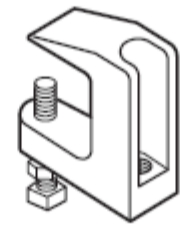

Wide mouth beam clamp



Purlin clamp

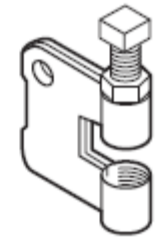

Steel C-clamp

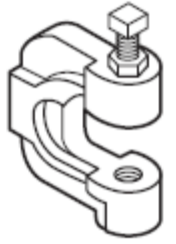

Malleable iron C-clamp

Concrete inserts

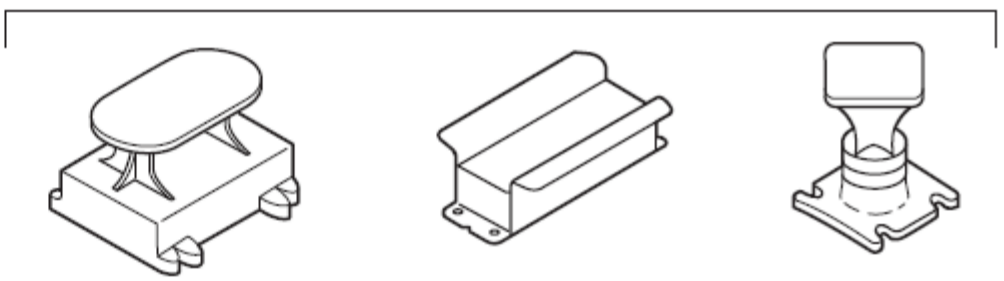

Retainer strap

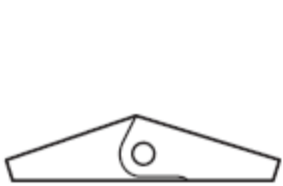

Toggle nut

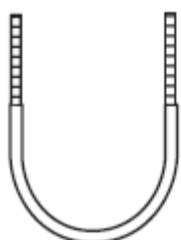

U-bolt



U-hook



Wraparound U-hook

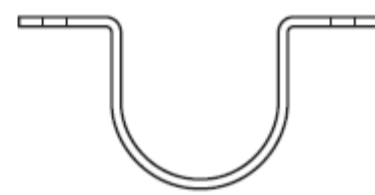

Short strap

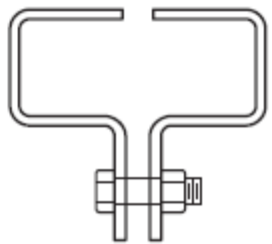

Wood beam clamp

Post-installed anchors



Wedge anchor

Drop in



Rod coupling

Powder-driven



Concrete

Steel

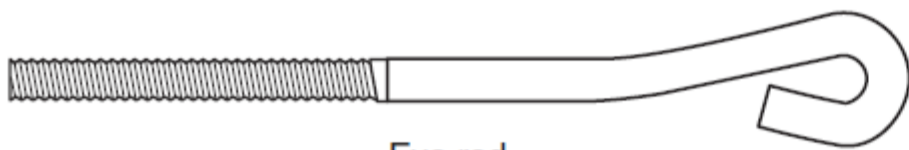

Eye rod

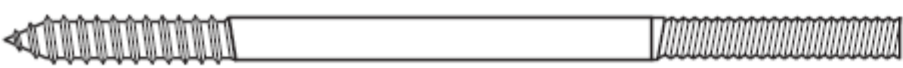

Coach screw rod



All thread rod



Lag screw

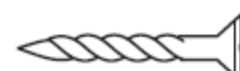

Drive screw



Wood screw

FIGURE A.9.1.1 Common Types of Acceptable Hangers.